

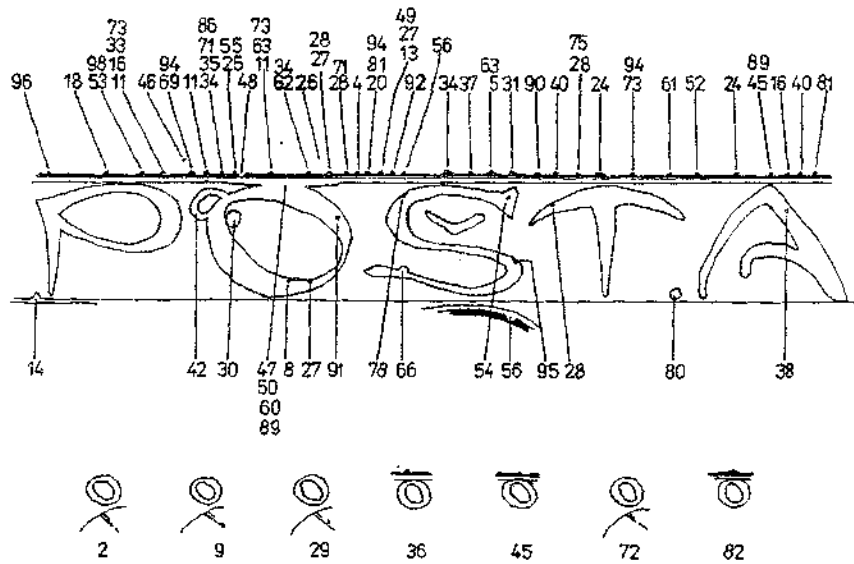

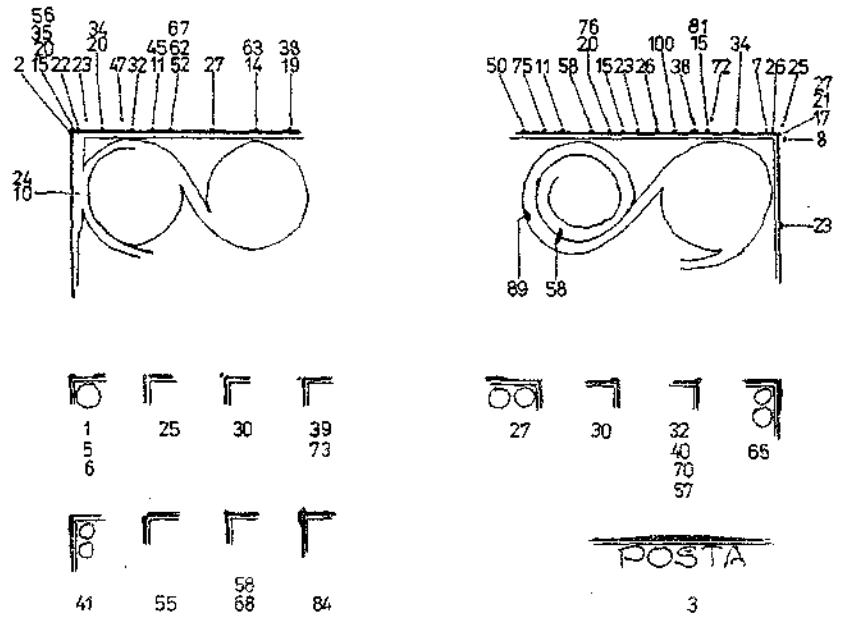















Details



KNHTISK

Series I: Plating the Hradčany. Vol. 4: Fourth Design. No. 3: 300h.

					
4 6 13 16 17 21 24 28 31 38 45 61 71 73 78 81 82 83 85 86 87 88 90 93 94 99 100	19	79 97 98	5 7 48 53 55	8 20 47 49 53 54 57 59 76 77 89 91 95 96	80
					
		6	96	8 19	100

						
26 30 32 45 66 80	11 13 14 15 17 22 23 25 26 28 31 33 34 35 37 38 39 41 42 44 46 50 52 56 60 62 63 64 65 67 68 69 70 97 99	4 12 18 20 21 24 27 29 36 40 43 44 48 49 51 55 61 71 72 73 74 75 81 83 84 90 92 95 100	5 78 87 88	9 10 16 76 85 94	7 54 57 79 86 91	47 53 58 59 77 82 89 93 98

KNHTISK

Series I: Plating the Hradčany. Vol. 4: Fourth Design. No. 3: 300h.

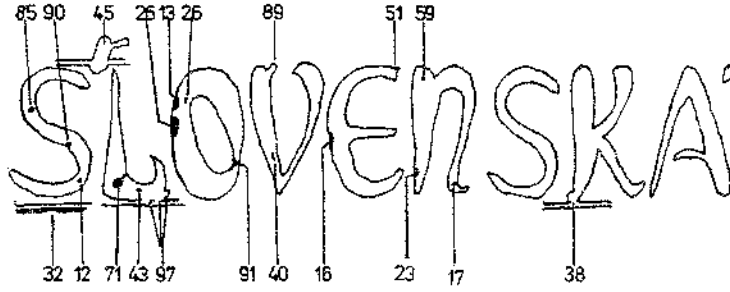
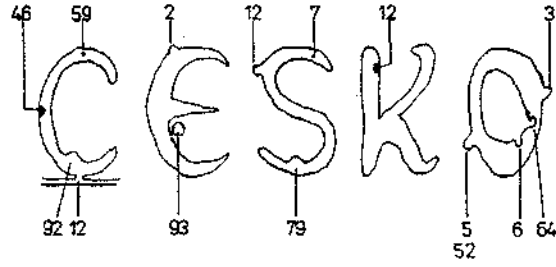

80

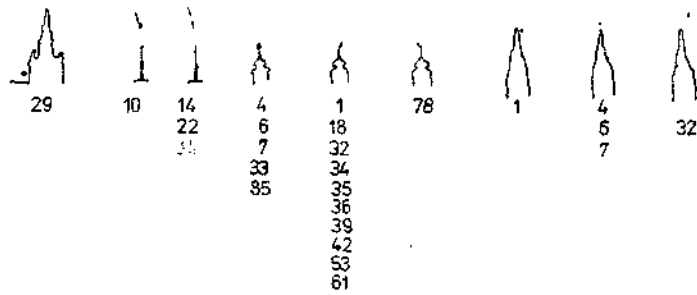
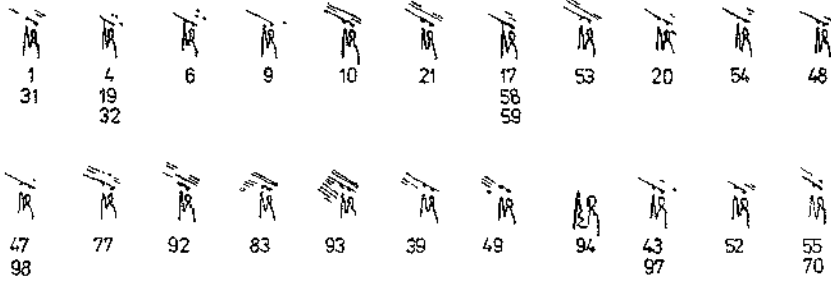

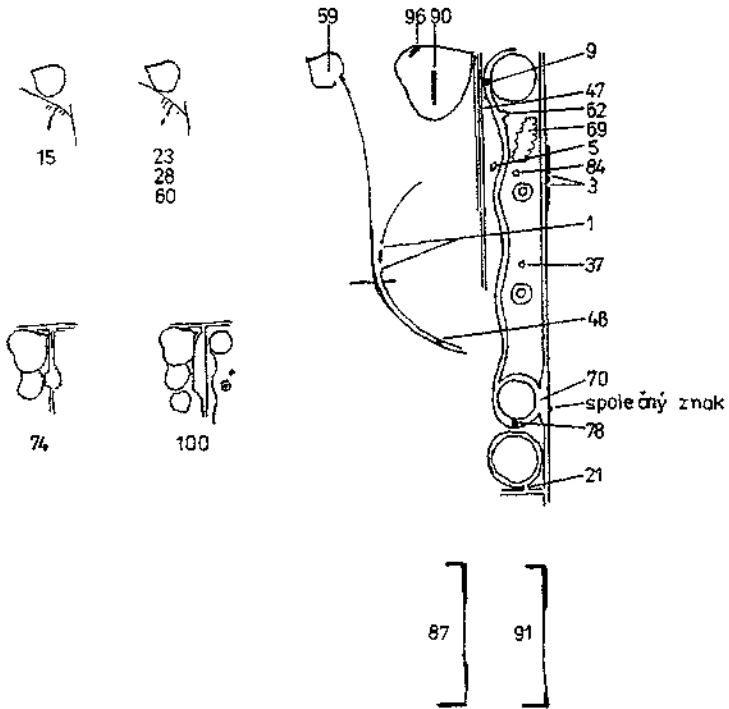
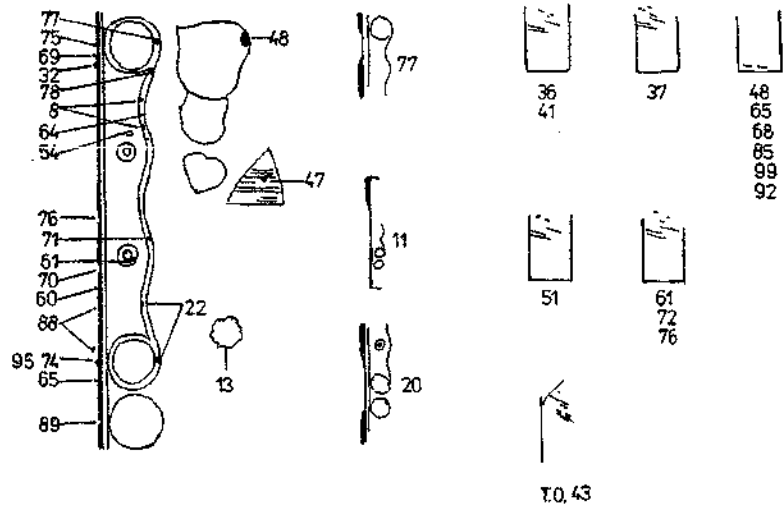

T.O. – On some prints.

Společný znak – common mark.

Note: Near the bottom of the top left drawing is the number 88. In the text, this feature (two dots) is attributed to position 82, not 88. May 18, 2003.

KNHTISK

Series I: Plating the Hradčany. Vol. 4: Fourth Design. No. 3: 300h.

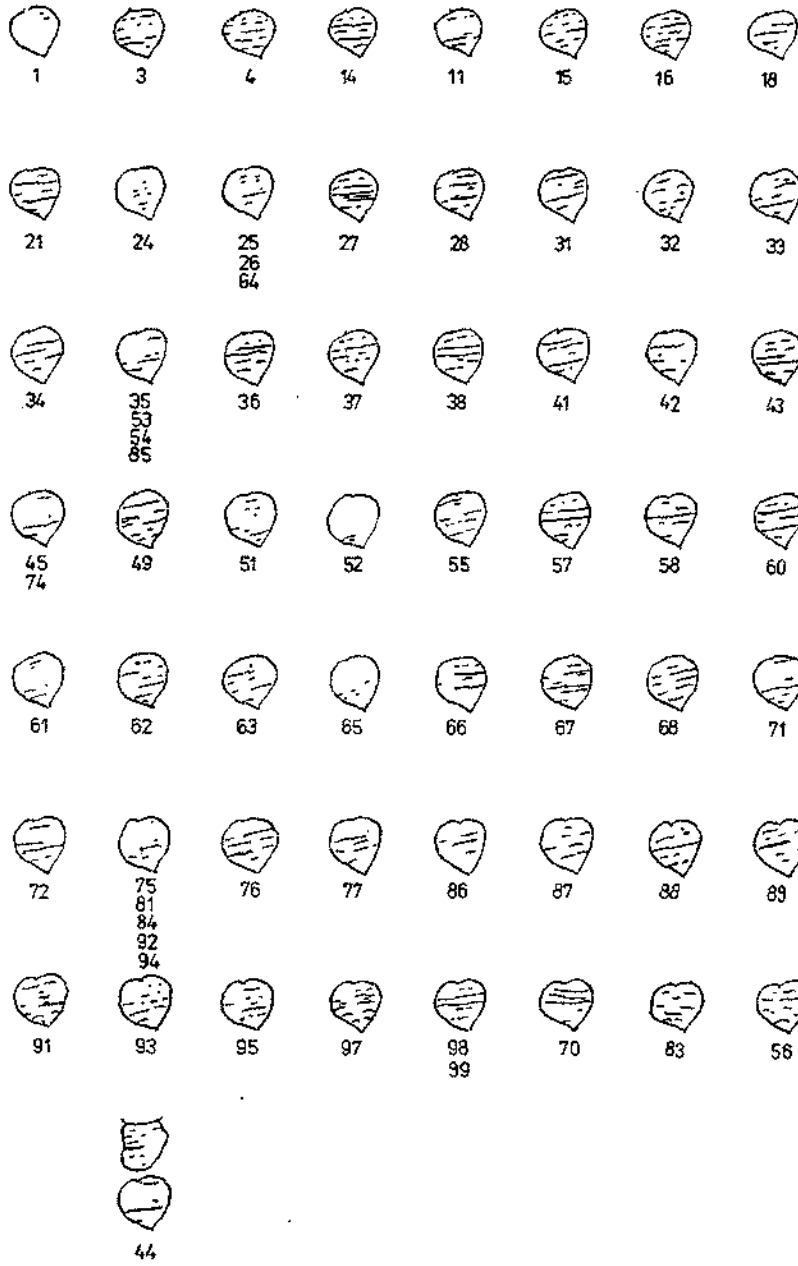

KNHTISK

Series I: Plating the Hradčany. Vol. 4: Fourth Design. No. 3: 300h.

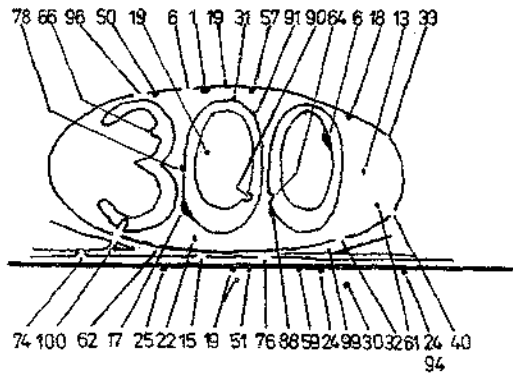
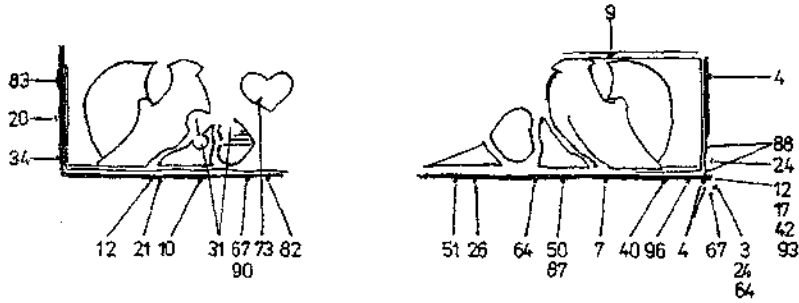
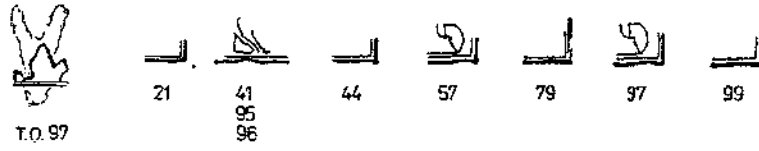

MUSHA	MUSHA	(HA)
2	4	19
5		86